

INSTALLATION INSTRUCTIONS

HONEYCOMB SHADES

Bottom-Up Lift&Lock Two-Fabric-Combo Lift & Lock

Thank you for your purchase. This shade has been custom built for you from the highest quality materials. To avoid errors and save valuable time, please read these instructions before installing your new shades.

TOOLS YOU WILL NEED

1. Pencil or Marker
2. Measuring Tape
3. Phillips Screwdriver
4. Carpenter's Level
5. Power Drill
6. Mounting Fasteners
7. 3/32" Drill Bit & 1/4" Hex Nut Driver Bit

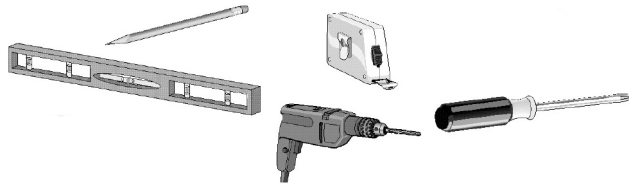



Mounting Surface	Fastener
Drywall, Plaster	Wall Anchors, Expansion Bolts (Not provided) 
Metal	Sheet Metal Screws (Not provided) 
Wood	No. 6 Hex Head Screws (Provided) 

TABLE OF CONTENTS

Getting Started	Page 2
Mounting Type	Page 2
Bracket Installation	Page 2
Inside Mount	Page 3
Outside Mount	Page 3
Side Mount	Page 3
Installing and Removing the Shade	Page 4
Operating the Shade	Page 4
Adjusting the Shade	Page 4
Child Safety	Page 4

GETTING STARTED

All of the required installation components are wrapped in your package along with these instructions. Check that the parts you have correspond to the parts shown below.

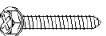
NOTE: Some parts may vary depending upon your chosen mounting options.

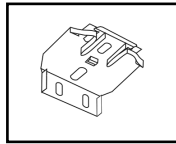

Installation Brackets

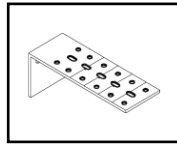

Extension Bracket
(optional)

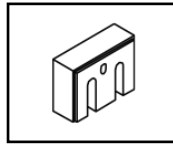

Spacer Blocks
(optional)

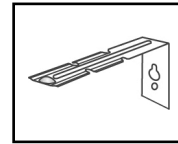

Side Mount Bracket
(optional)

Mounting Types

If the installation brackets are mounted correctly, the rest of the installation process will follow easily. To prepare for this important first step, review the mounting types and basic window terminology illustrated below.

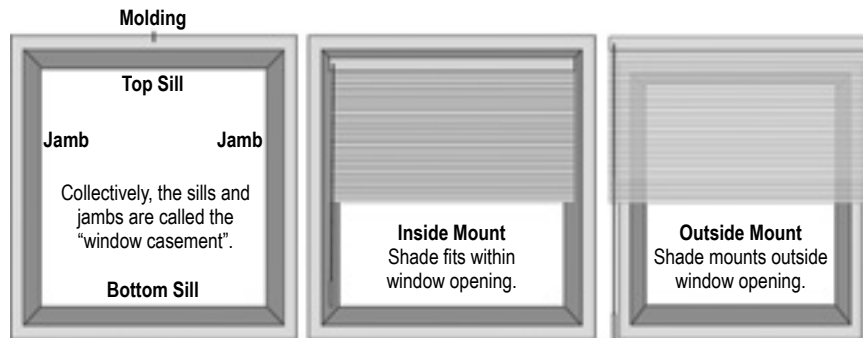

Bracket Installation

Installation brackets may be used for **INSIDE** or **OUTSIDE** mounts.

Mounting the brackets level is essential for proper operation of the shade. Shim the brackets if necessary to achieve a level alignment.

The bracket requirements and placements are the same for inside and outside mounts. Refer to the following spacing diagram and bracket requirement chart.

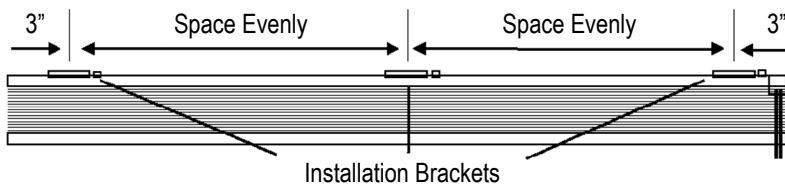

Installation Bracket Requirement Chart	
Shade Width	Brackets Required
12" to 31"	2
31-1/8" to 72"	3
72-1/8" to 84"	4

Inside Mount

For inside mounts the installation brackets will be screwed in place through the top two holes of each bracket.

Refer to the depth requirements chart:

NOTE: Prior to mounting the brackets, add any clearance depth required to avoid obstructions such as window cranks or handles.

Minimum Depth	Fully Recessed
1"	2-1/2"

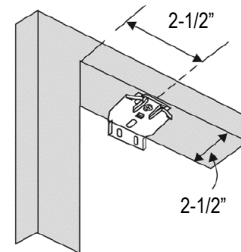

ATTACH THE BRACKETS

1. Screw the bracket through top two holes to desired window sill location.
 - Use a 3/32" drill bit to drill holes for the screws.
2. Ensure all brackets are level and aligned.

IMPORTANT: If you are fastening the installation brackets to drywall, be sure to use wall anchors and follow the instructions provided with the anchors. (Anchors not provided.)

Outside Mount

For outside mounts the installation brackets will be screwed in place through the two back holes of each bracket.

Refer to the minimum surface height chart.

ATTACH THE BRACKETS

1. Screw the bracket through back two holes to desired location.
 - Use a 3/32" drill bit to drill holes for the screws.
2. Ensure all brackets are level and aligned.

IMPORTANT: If you are fastening the installation brackets to drywall, be sure to use wall anchors and follow the instructions provided with the anchors. (Anchors not provided.)

Minimum Height
3/4"

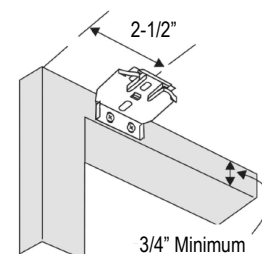

SPACER BLOCKS (optional)

1. Spacer blocks will be attached to the end of each bracket.
2. Ensure the screws are long enough to secure brackets to surface.
3. Do not use more than three spacer blocks per bracket.
4. If installing extension brackets, do not use spacer blocks.

EXTENSION BRACKETS (optional)

1. Position the extension brackets to the desired wall location.
2. The bracket tops must be aligned and level to one another.
3. Mount the extension brackets through the back holes with two screws.
4. Attach the installation brackets to the extension brackets.

Installation brackets attached to extension brackets with the included screws and nuts.

Use the same holes for all brackets to ensure even projection from the surface.

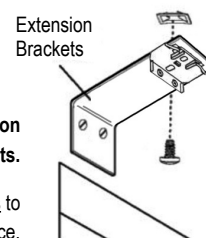

Side Mount

1. Align the bracket top with the desired height of the top of the head rail. Mark holes for screws, remove brackets and drill holes.
2. Insert screws for keyhole slots only. Approximately 1/8" of the screw should be left protruding.
3. Pull the end cap out of the headrail and slide the bracket on as shown. Replace the end cap and then slide the bracket all the way into the headrail.

Install the second bracket in the same manner as the first bracket.

Hook one bracket onto the screw in the window frame, using the keyhole slot. Bring the other end bracket over the screw at the other side of the frame. Slide down, flexing bracket inward until the screw engages in the keyhole slot.

Make sure both brackets are slipped down all the way in the keyhole slot so that the screw is in the top portion of the keyhole slot. Install a screw in the bottom hole of each bracket. Tighten all screws.

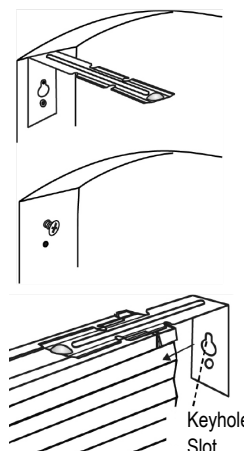

Installing and Removing the Shade

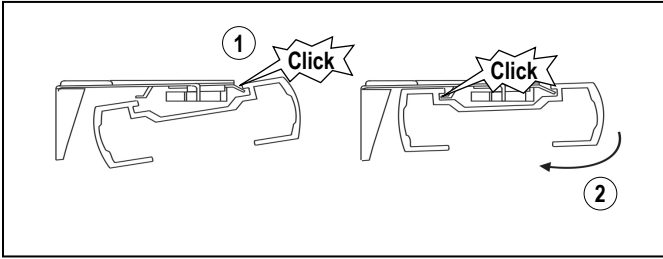

Installing the Shade

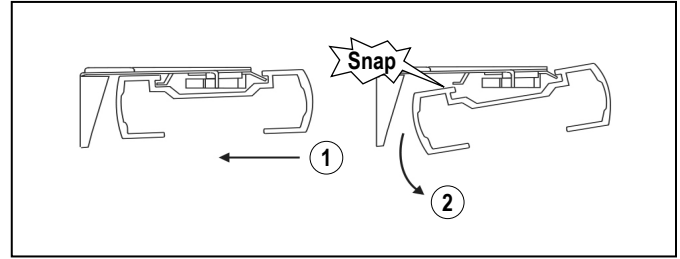

Removing the Shade

Operating the Shade

TO RAISE AND LOWER THE CORDLESS LIFT & LOCK SHADE

1. Push and hold the **button** on the bottomrail handle.
2. Raise or lower the shade to the desired position.
3. Release the button to lock the shade into place.

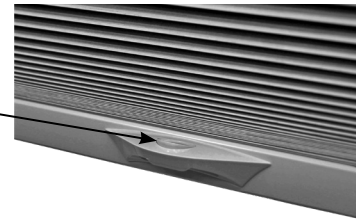

Adjusting the Shade

1. Raise and lower the shade several times.
2. If the length is incorrect or the bottom rail is not level, use the following steps to correct.

HEADRAIL SHADE ADJUSTMENT

1. Remove the headrail.
2. Lift headrail on the side to be adjusted.
3. Use a screwdriver or dime.
 - Turn screw clockwise to lift that side of the shade.
 - Turn screw counter clockwise to lower that side of the shade.
 - Half a revolution is 1/4" adjustment (maximum adjustment is 1/2").

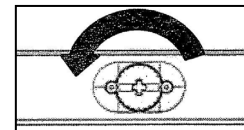
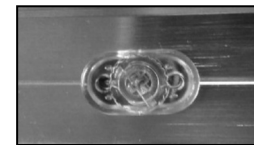

Lower Shade Side

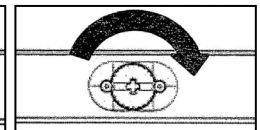

Lift Shade Side

CHILD SAFETY

WARNING

STRANGULATION HAZARD –
Young children can be strangled by cords.

Immediately remove this product if a cord longer than 22 cm or a loop exceeding 44 cm around becomes accessible. Rev 7/21 Print 7/21

MISE EN GARDE

RISQUE D'ÉTRANGLEMENT –
Les enfants en bas âge

peuvent s'étrangler avec des cordes. Enlevez immédiatement ce produit si une corde mesurant plus de 22 cm devient accessible ou si le contour d'une boucle de plus de 44 cm devient accessible.

INSTALLATION INSTRUCTIONS

HONEYCOMB SHADES

Cordless Lift System Motorization

Thank you for your purchase. This shade has been custom built for you from the highest quality materials. To avoid errors and save valuable time, please read these instructions before installing your new shades

TOOLS YOU WILL NEED

1. Pencil or Marker
2. Measuring Tape
3. Phillips Screwdriver
4. Carpenter's Level
5. Power Drill
6. Mounting Fasteners
7. 3/32" Drill Bit & 1/4" Hex Nut Driver Bit

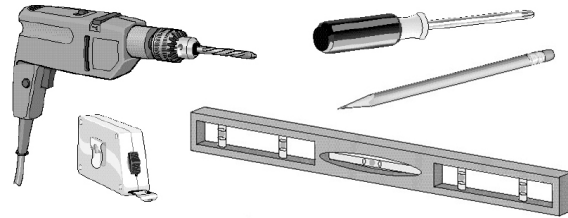

Mounting Surface	Fastener
Drywall, Plaster	Wall Anchors, Expansion Bolts (Not provided) 
Metal	Sheet Metal Screws (Not provided) 
Wood	No. 6 Hex Head Screws (Provided) 

TABLE OF CONTENTS

Getting Started	Page 2
Mounting Type	Page 2
Bracket Installation	Page 2
Motorized Shades	Page 3
Inside Mount	Page 3
Outside Mount	Page 3
Installing the Shade	Page 4
Attaching Hold-Down Brackets (optional)	Page 4
Adjusting the Shade	Page 4
Operating the Shade	Page 5
Care and Cleaning	Page 5
Child Safety	Page 5

GETTING STARTED

Thank you for purchasing this Honeycomb Shade. All of the required installation components are wrapped in your package along with these instructions. With proper installation, operation, and care, your new shades will provide years of beauty and performance. Please thoroughly review this instruction booklet before beginning the installation. Check that the parts you have correspond to the parts shown below.

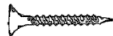
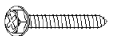
Note: Some parts may vary depending upon your chosen shade system or mounting option.

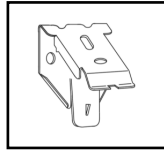

Installation Brackets

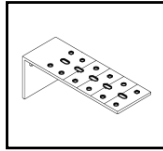

Extension Bracket (optional)

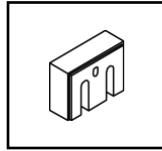

Spacer Blocks (optional)

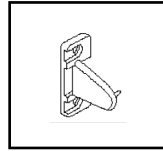

Hold Down Brackets (optional)

Cordless Lift Shade Only



Clear Plastic Insert — if ordered

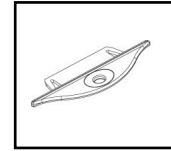

Cordless Lift Handle (Clear or Color Coordinated)

Mounting Types

If the installation brackets are mounted correctly, the rest of the installation process will follow easily. To prepare for this important first step, review the mounting types and basic window terminology illustrated below.

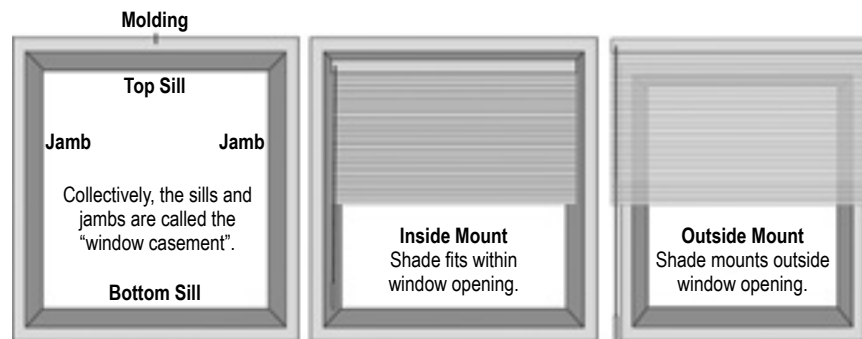

Bracket Installation

The installation brackets may be for **INSIDE** or **OUTSIDE** mounts.

Mounting the brackets level is essential for proper operation of the shade.

Shim the brackets if necessary to achieve a level alignment.

The bracket requirements and placements are the same for inside and outside mounts.

Refer to the following spacing diagram and bracket requirement chart.

Shade Width	Brackets Required
18" to 38"	2
38-1/8" to 72"	3
72-1/8" to 106"	4
106-1/8" to 140"	5
140-1/8" to 174"	6

When installing motorized bottom-up shades with an external battery pack refer to the chart below:

External Battery - Mounted away from the Headrail

Honeycomb & Hybrid Pleat

Inside (IB) Mount	
Minimum mounting depth	3/4"
Minimum mounting depth, flush mount	2-1/8"
Outside (OB) Mount	
Minimum flat vertical surface	1-1/2"

External Battery - Mounted to the back from the Headrail*

Honeycomb & Hybrid Pleat

Inside (OB) Mount	
Minimum mounting depth	2-5/8"
Minimum mounting depth, flush mount	3-1/4"
Outside (OB) Mount	
Minimum flat vertical surface	1-1/2"

NOTE: Extension Brackets required for External Battery Bottom-up Shades - Mounted to the back of the headrail.

Motorized Shades

Bottom-Up Shades — Prior to installing the shade, attach the external battery pack to the motor and pair the motor with the remote using the instructions included with the remote.

Two-Fabric-Combo — Features an internal battery. Charging port and reset button are found in either the left or right end piece. Follow the instructions included with the remote to pair with the motor.

Inside Mount

For inside mounts the installation brackets will be screwed in place through the top two holes of each bracket. Refer to the mounting depth chart:

Minimum Depth	Fully Recessed
3/4"	2-1/8"

NOTE: Prior to mounting the brackets, add any clearance depth required to avoid obstructions such as window cranks or handles.

ATTACH THE BRACKETS:

- Screw installation brackets through top two holes to desired window sill location.
 - Use a 3/32" drill bit to drill holes for the screws.
- Ensure all brackets are level and aligned.

IMPORTANT: If you are fastening the installation brackets to drywall, be sure to use wall anchors and follow the instructions provided with the anchors. (Anchors not provided.)

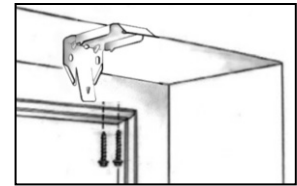

Outside Mount

For outside mounts the standard installation brackets will be screwed in place through the two back holes of each bracket. Refer to the minimum surface height chart:

Minimum Height
1-1/2"

ATTACH THE BRACKETS:

- Screw standard brackets through two back holes to desired location.
 - Use a 3/32" drill bit to drill holes for the screws.
- Ensure all brackets are level and aligned.

IMPORTANT: If you are fastening the installation brackets to drywall, be sure to use wall anchors and follow the instructions provided with the anchors. (Anchors not provided.)

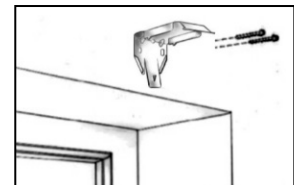

EXTENSION BRACKETS (optional):

- Position the extension brackets to the desired wall location.
- The bracket tops must be aligned and level to one another.
- Mount the extension brackets through the back holes with two screws.
- Attach installation brackets to extension brackets with included screws & nuts.

NOTE: Use the same holes for all brackets to ensure even projection from the surface.

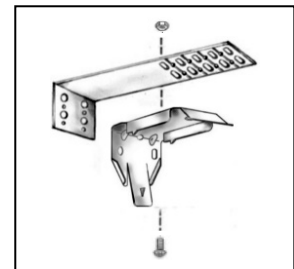

SIDE MOUNT WITH EXTENSION BRACKETS (optional):

Important: Not available with all operating systems.

- Measure from window sill up to desired mounting position on each side of the window frame.
- Mark position.
- Mount Extension Brackets on each side of window frame, as shown. Make sure to confirm that the headrail will sit perfectly level.
- Once the Extension Brackets are installed and properly positioned, attach the mounting brackets using the nuts and bolts provided.

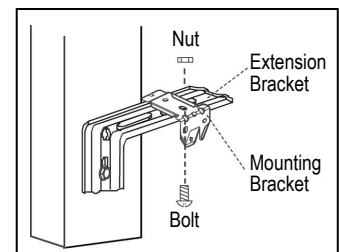

Installing the Shade

FOR MOTORIZED SHADES (ONLY)

IMPORTANT: For Motorized shades only, make sure the remote control is paired to the motor prior to installing in the window.

FOR CORDLESS LIFT SHADES (ONLY)

- The shade will come with the color coordinated textured handle pre-inserted into the moving rail(s).
- If desired, a clear textured handle or a clear plastic insert are available and must be selected at the time the order is placed.

NOTE: The plastic handle is not easily removable. Should it become necessary to remove the handle please contact customer service.



MOUNTING THE HEADRAIL

- With the front side of the shade facing you, tilt the headrail slightly backward to angle the front inside lip to the brackets.
- Rotate headrail back and upward to snap in it into place.

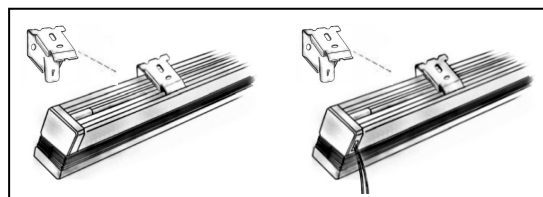

Attaching Hold-Down Brackets (optional)

1. Lower the shade and place the hold down pins into the bottom rail end caps.
2. Mark the hold down bracket locations on the mounting surface.
3. With the brackets level, attach them using two screws.

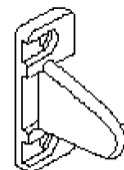

Adjusting the Shade

- Raise and lower the shade several times.
- If the length is incorrect or the bottom rail is not level, use the following steps to correct.

BOTTOMRAIL SHADE ADJUSTMENT

1. Lift bottomrail on the side to be adjusted. This will take the weight off the cord.
2. Use a screwdriver or dime.
 - Turn screw clockwise to lift that side of the shade.
 - Turn screw counter clockwise to lower that side of the shade.
 - Half a revolution is 1/4" adjustment (maximum adjustment is 1/2").

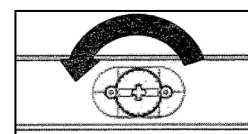
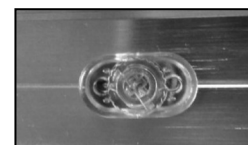

Lower Shade Side

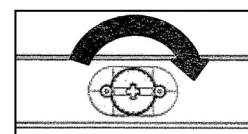

Lift Shade Side

Operating the Shade

CORDLESS LIFT SHADES

TO RAISE AND LOWER THE SHADE:

1. Hold the handle in the center portion of the bottomrail to ensure level movement.
2. Shades over 42" in width will have 2 handles evenly positioned within hands reach along the center portion of the bottomrail to ensure level movement.
3. Lower the shade by gently pulling downward to the desired position.
4. Raise the shade by gently pushing upward to the desired position

CARE AND CLEANING

Honeycomb shades are made of an anti-static, dust resistant fabric which repels dirt and dust. For most of these fabrics, the following options are available if your shade needs cleaning.

DUSTING: Regular light dusting with a feather duster is all the cleaning that is needed in most circumstances.

VACUUMING: Use a hand-held vacuum with low suction for more thorough dust removal.

SPOT CLEANING: Use the following steps for spot cleaning: (1) Prepare a solution of warm water and mild dish-washing detergent. (2) Dampen a clean cloth in the solution and ring it out. (3) Dab the spot with the dampened cloth until it is gone. **DO NOT RUB THE FABRIC.** (4) Allow the shade to dry in the completely lowered position.

CAUTION: *Avoid creasing Blackout fabrics during cleaning.*

DEEP CLEANING: Use the following steps for deep cleaning: (1) Immerse shade in basin or bathtub filled with warm water and mild detergent. (2) Rinse with clean water. (3) Fully raise shade and tilt to eliminate excess water, (4) Reinstall damp shade, lower it, and let it dry completely.

CAUTION: *Do not immerse Blackout fabrics. Do not immerse the headrail or any fabric-wrapped rail.*

ULTRASONIC CLEANING: Standard shades, except those made with Blackout Lining can be ultrasonically cleaned by a professional.

- Specify that a mild detergent be used.
- Never immerse the headrail or any fabric-wrapped rail in the solution.
- Dry the shade completely in the lowered position.

CAUTION: *Do not ultrasonically clean Blackout fabrics. Do not immerse headrail.*

CHILD SAFETY



WARNING

STRANGULATION HAZARD –
Young children can be strangled by cords.

Immediately remove this product if a cord longer than 22 cm or a loop exceeding 44 cm around becomes accessible. Rev 7/21 Print 7/21



MISE EN GARDE

RISQUE D'ÉTRANGLEMENT–
Les enfants en bas âge

peuvent s'étrangler avec des cordes. Enlevez immédiatement ce produit si une corde mesurant plus de 22 cm devient accessible ou si le contour d'une boucle de plus de 44 cm devient accessible.



15 Channel Remote Control Programming Guide

Specifications

- Up to 15 channels with 3V (CR2450) battery, magnetic holder included
- Channel 0 controls all shades assigned to remote; ability to hide extra channels
- Favorite position activated by quick touch of a button
- Locking feature prevent unwanted configuration changes



AMP™ Motorization Table of Contents

Declarations	3
Safety Instructions	4
AMP™ Remote Overview	5
AMP™ Remote Functions	6
P1 Button Instructions	7
Initial Set-up	8
Adjust Limits	9
Favorite Position	10
Add or Remove Additional Remote	11
Adjust Motor Speed	12
Roller or Sheer Mode	13
Quick Index	14
Troubleshooting	14



Please scan QR code to watch videos for product programming



Declarations

U.S. Radio Frequency FCC Compliance

This device complies with Part 15 of the FCC Rules. Operation is subject to the following two conditions:

- (1) This device may not cause harmful interference, and
- (2) This device must accept any interference received, including interference that may cause undesired operation.

This equipment has been tested and found to comply with the limits for a Class B digital device, pursuant to Part 15 of the FCC Rules. These limits are designed to provide reasonable protection against harmful interference in a residential installation. This equipment generates, uses, and can radiate radio frequency energy and, if not installed and used in accordance with the instructions, may cause harmful interference to radio communications. However, there is no guarantee that interference will not occur in a particular installation. If this equipment does cause harmful interference to radio or television reception, which can be determined by turning the equipment off and on, the user is encouraged to try to correct the interference by one or more of the following measures:

- Reorient or relocate the receiving antenna.
- Increase the separation between the equipment and receiver.
- Connect the equipment into an outlet on a circuit different from that to which the receiver is connected.
- Consult the dealer or an experienced radio/TV technician for help.

Any Changes or modifications not expressly approved by the party responsible for compliance could void the user's authority to operate the equipment.

ISED RSS Warning:

This device complies with Innovation, Science and Economic Development Canada licence-exempt RSS standard(s). Operation is subject to the following two conditions: (1) this device may not cause interference, and (2) this device must accept any interference, including interference that may cause undesired operation of the device. Le présent appareil est conforme aux CNR d'ISED applicables aux appareils radio exempts de licence. L'exploitation est autorisée aux deux conditions suivantes: (1) l'appareil ne doit pas produire de brouillage, et (2) l'utilisateur de l'appareil doit accepter tout brouillage radioélectrique subi, même si le brouillage est susceptible d'en compromettre le fonctionnement.

Safety Instructions

Attention

Never drop, knock, drill or submerge the motor. Keep the power cable in the proper position as shown below.

Read all safety instructions before installation.

Incorrect installation can lead to serious injury and will void manufacturer's liability and warranty.

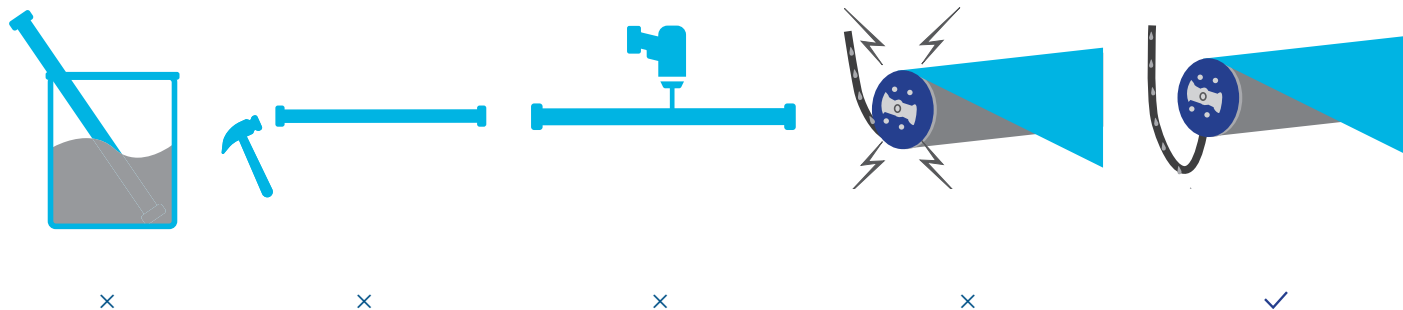

Important Safety Instructions

1. Do not expose motor to humid, damp, or extreme temperature conditions.
2. Do not drill into motor.
3. Do not cut the antenna. Keep it clear from metal objects.
4. Do not allow children to play with this device.
5. If the power cable or connector is damaged, do not use.
6. Ensure the correct crown and drive adaptor are used.
7. Ensure the power cable and aerial is clear and protected from moving parts.
8. Cable routed through walls should be properly isolated.
9. Motor is to be mounted in horizontal position only.
10. Before installation, remove unnecessary cords and disable equipment not needed for powered operation.
11. Installation and programming should be performed by a qualified professional. Use or modification outside the scope of these instructions may void warranty.



Do not dispose of in general waste.

Please recycle batteries and damaged electrical products appropriately.

AMP™ Remote Overview

1. Fields of Application

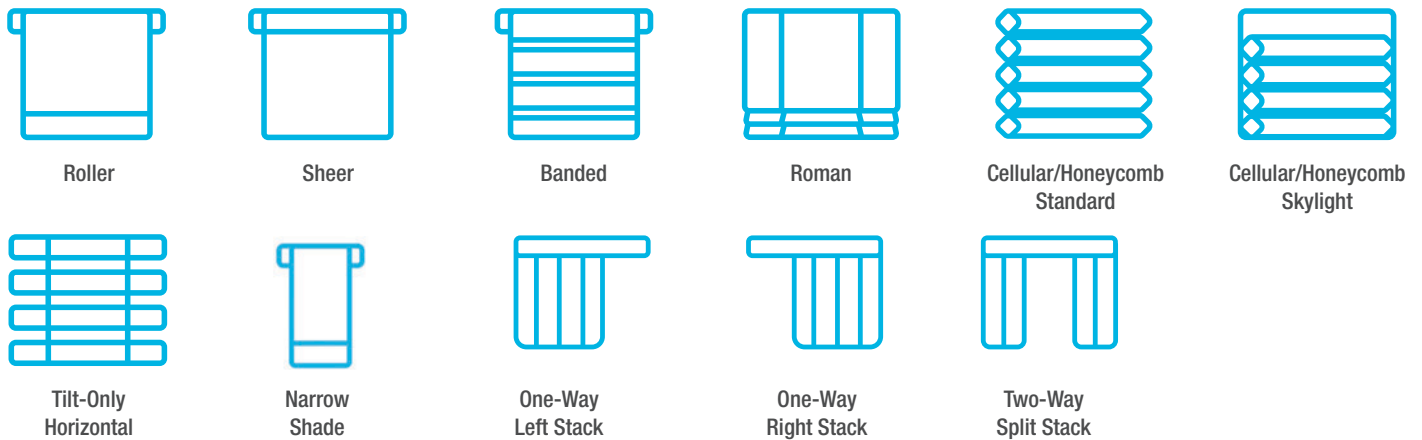

2. Specification

Voltage	3V (CR2450)
Radio Frequency	433.92 MHz Bi-directional
Transmitting Power	10 milliwatt
Operating Temperature	14°F to 122°F (-10°C to 50°C)
RF Modulation	FSK
Lock Function	Yes
IP Rating	IP20
Transmission Distance	up to 200m (outdoor)

3. Remote Button Instructions

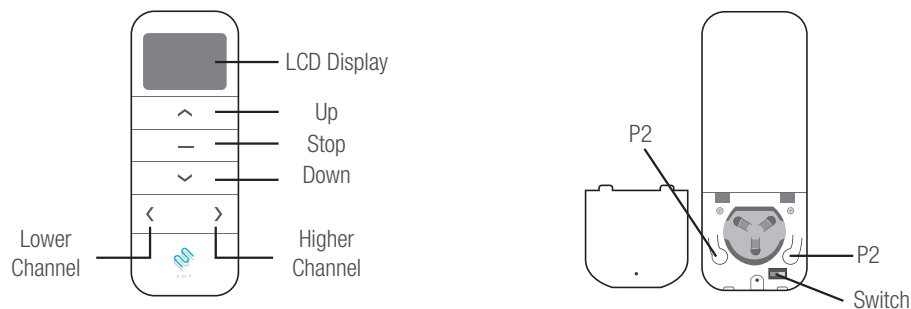

*For AMP™ Drapery, press "Up" for open; press "Down" for close.

4. Replace/Install CR2450 Battery

- Unscrew with the screwdriver then gently press down the cover.
- Install battery (CR2450) with positive (+) side facing up.
- Gently assemble the cover back and replace screw with screwdriver.

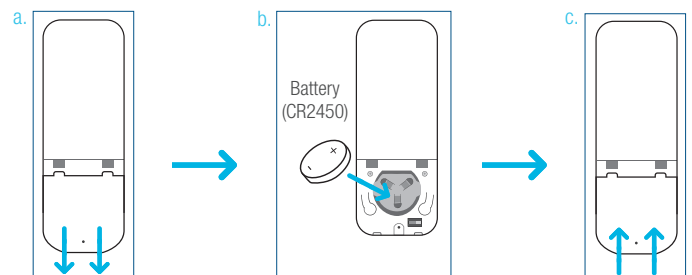

1. Channel Options

Select A Channel

- Press “<” button on the remote to select a lower channel.
- Press “>” button on the remote to select a higher channel.

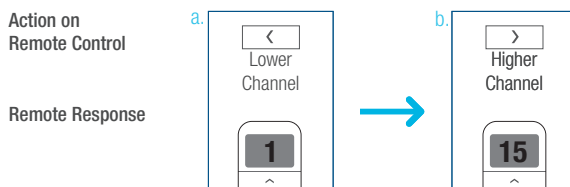

Hide Unused Channels

- Press and Hold (about 3 sec) “<” and “>” buttons simultaneously until remote control displays “C” (channel).
- Press “<” or “>” button to select required quantity of channel (between 1 to 15).
- Press “Stop” button to confirm selection (the example shows a 5-channel selection). The LED will display “0” (OK) once to confirm selection.

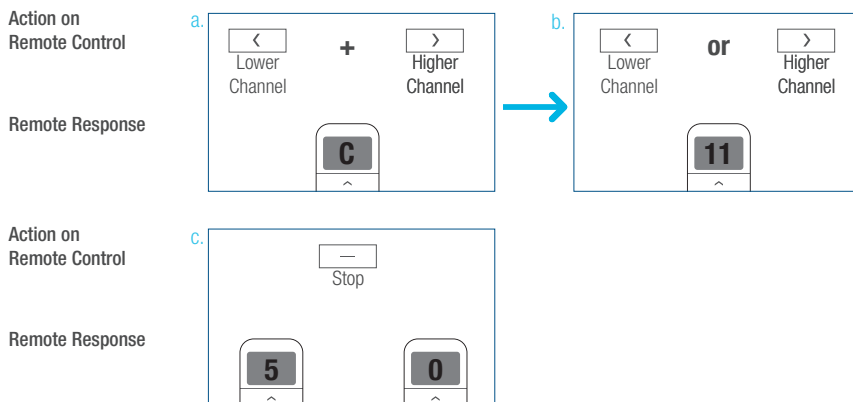

2. Advanced Setting - Disable Limit Setting

- Remove the cover from the backside of remote, the lock switch is in the right corner.
- Move the switch to the “Lock” position to disable the following commands, remote will show “L” (lock):
 - Change Motor Direction
 - Setting the Upper and Lower Limit
 - Adjust Limit
 - Roller Mode or Sheer Mode
- Move the switch to “Unlock” position to assess all remote functions, remote will show “U” (unlock).

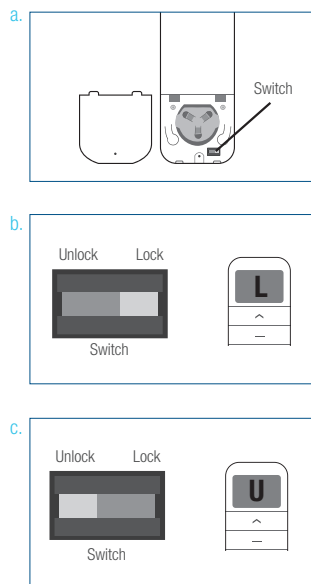

*This advanced feature is intended to be used after all shade programming is completed. User Mode will prevent accidental or unintended changing of limits.

P1 Button Instructions

2. P1 Button Location

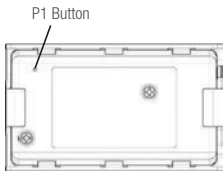

AMPTILT

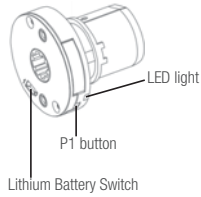

AMP25B / AMP28B / AMP25BDC

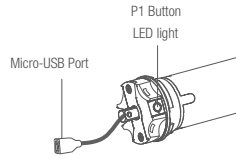

AMP35B

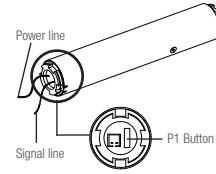

AMPCEL

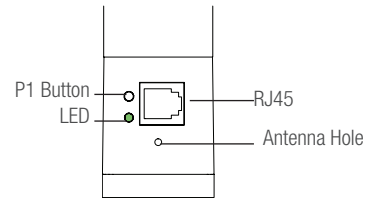

AMP DRAPERY MOTOR

2. P1 Button Instruction

AMPCEL and AMPTILT motors DO NOT BEEP

1 Test Motor

Happening as you press for 1 second



Press P1
Less than 1 sec.

when released

Motor Response: Wakes & Runs

2 Activate Pairing Mode

Happening as you press for 2 seconds



Press P1
Approx. 2 sec.

Until Shade: Jog x1

when released

Motor Response: Beep x1

3 Sleep Mode

Happening as you press for 6 seconds



Press P1
Approx. 6 sec.

Until Shade: Jog x2

when released

Motor Response: Beep x2

4 Reverse Direction

Happening as you press for 10 seconds



Press P1
Approx. 10 sec.

Until Shade: Jog x3

when released

Motor Response: Beep x3

5 Reset To Factory Settings

Happening as you press for 14 seconds



Press P1
Approx. 14 sec.

Until Shade: Jog x4

when released

Motor Response: Beep x4

Initial Set-up

1. Pair / Unpair Remote Control

- Press **“P1” button** (about 2 sec) on the motor head until motor jog x1 and beep x1.
- In the next 10 secs, press and hold **“Stop”** button on the remote control until motor jog x2 and beep x3.

* Repeat the same procedure to unpair remote control.

Action on Motor

Motor Response

Action on Remote Control

Motor Response

AMPCEL and AMPTILT motors DO NOT BEEP

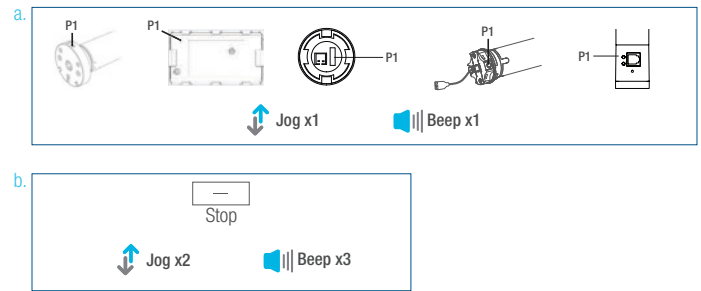

2. Change Motor Direction (if necessary)

Press **“Up”** or **“Down”** button to check if the shade moves in the desired direction.

If you need to reverse the direction, press and hold (about 2 sec) **“Up”** and **“Down”** buttons simultaneously until motor jog x1 and beep x1.

Action on Remote Control

Motor Response

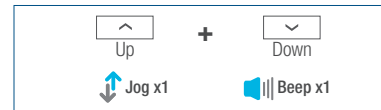

*The operation is only valid when there are no limits. If the motor has already set the upper and lower limit, then you can only switch direction by pressing P1 button (See P1 button instructions).

3. Setting the Upper and Lower Limits

Set Upper Limit

- Press **“Up”** button to raise the shade, then press **“Stop”** button when it is in the desired upper limit.
- Press and hold (about 5 sec) **“Up”** and **“Stop”** buttons simultaneously until motor jog x2 and beep x3.

Action on Remote Control

Motor Response

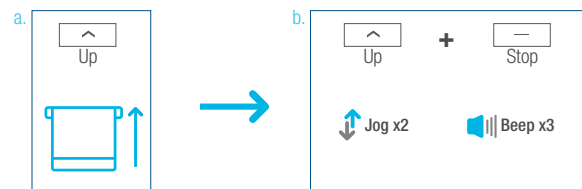

Set Lower Limit

- Press **“Down”** button to lower the shade, then press **“Stop”** button when it is in the desired lower limit.
- Press and hold (about 5 sec) **“Down”** and **“Stop”** buttons simultaneously until motor jog x2 and beep x3.

Action on Remote Control

Motor Response

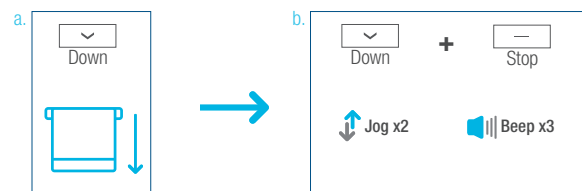

*If you exit the limit setting status before you finish the limit settings, the motor will take the previous existing limits.

Adjust Limits

1. Adjust the Upper Limit

a. Press and hold (about 5 sec) **“Up”** and **“Stop”** buttons simultaneously until motor jog x1 and beep x1.

b. Use **“Up”** button to raise the shade to the desired highest position, and use **“Up”** or **“Down”** button to do the final adjustment if necessary.

c. Press and hold (about 5 sec) **“Up”** and **“Stop”** buttons simultaneously until motor jog x2 and beep x3.

Action on Remote Control

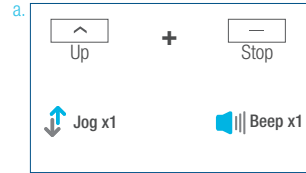

Motor Response

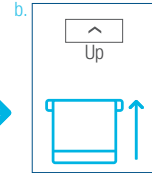

Action on Remote Control

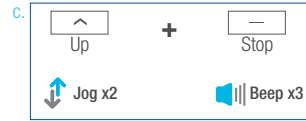

Motor Response

2. Adjust the Lower Limit

a. Press and hold (about 5 sec) **“Down”** and **“Stop”** buttons simultaneously until motor jog x1 and beep x1.

b. Use **“Down”** button to lower the shade to the desired lowest position, and use **“Up”** or **“Down”** button to do the final adjustment if necessary.

c. Press and hold (about 5 sec) **“Down”** and **“Stop”** buttons simultaneously until motor jog x2 and beep x3.

Action on Remote Control

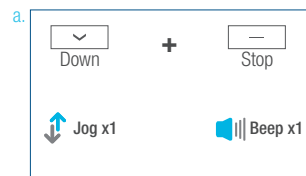

Motor Response

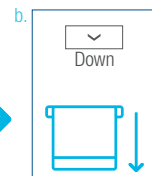

Action on Remote Control

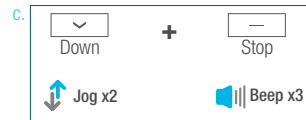

Motor Response

Favorite Position

1. Set Favorite Position

- a. Use **“Up”** or **“Down”** button to move the shade to desired Favorite position.
- b. Press one **“P2”** button on the back of remote control until motor jog x1 and beep x1.
- c. Press **“Stop”** button until motor jog x1 and beep x1.
- d. Once more, press **“Stop”** button until motor jog x2 and beep x3.

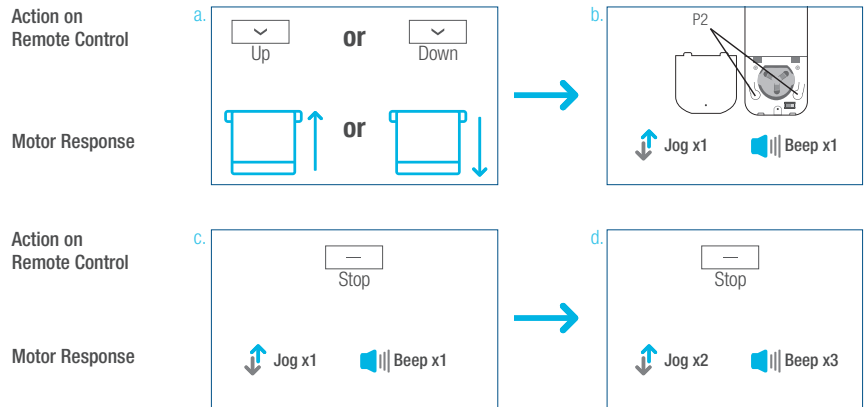

2. Send Shade to Favorite Position

Press and hold (about 2 sec) **“Stop”** button, motor will move to Favorite position.

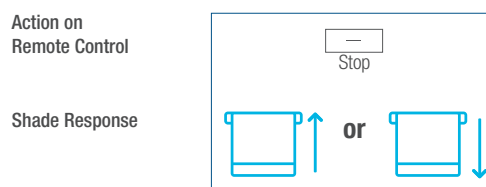

3. Delete Favorite Position

- a. Press one **“P2”** button until motor jog and beep x1.
- b. Press **“Stop”** button until motor jog and beep x1.
- c. Once more, press **“Stop”** button until motor jog x1 and long beep x1.

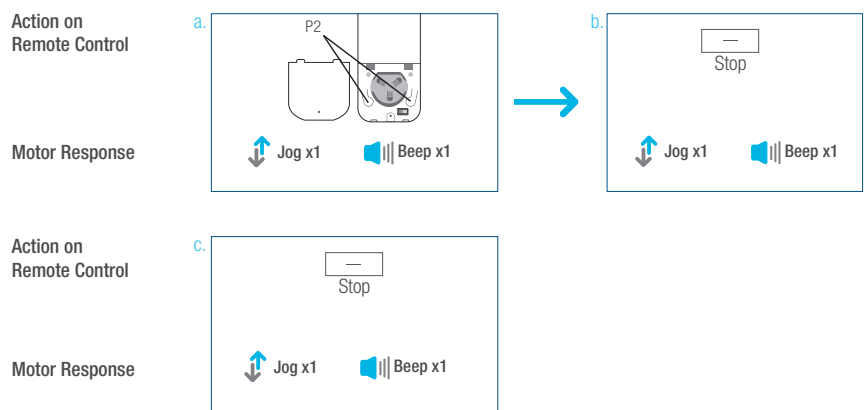

Add or Remove Additional Remote

1. Using Current Remote Control

a. On the **current** remote control, press one “P2” button until motor jog x1 and beep x1.

b. Once more, on the **current** remote control, press one “P2” button until motor jog x1 and beep x1.

c. On the **New** remote control, press one “P2” button until motor jog x2 and beep x3.

*Repeat the same procedure to remove additional remote control.

Action on Remote Control

Motor Response

Action on Remote Control

Motor Response

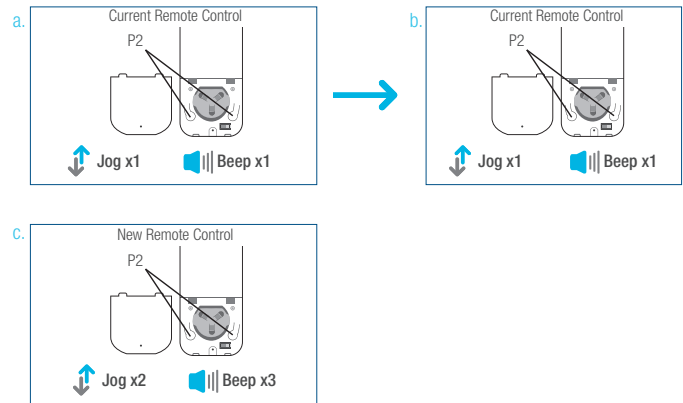

2. New Remote Control

Follow instructions on page 8 under the section **Pair / Unpair Remote Control**

Adjust Motor Speed

1. Acceleration Speed

- a. Press one “P2” button until motor jog x1 and beep x1.
- b. Press “Up” button until motor jog x1 and beep x1.
- c. Once more, press “Up” button until motor jog x2 and beep x1.

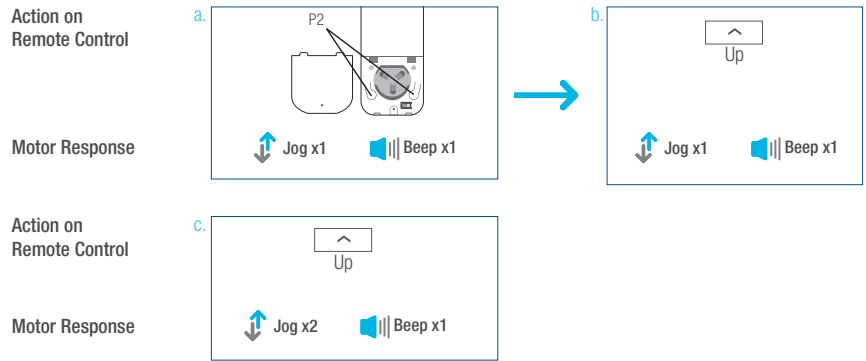

2. Deceleration Speed

- a. Press one “P2” button until motor jog x1 and beep x1.
- b. Press “Down” button until motor jog x1 and beep x1.
- c. Once more, press “Down” button until motor jog x2 and beep x1.

*If the motor has no response, it already has a Maximum or Minimum speed.

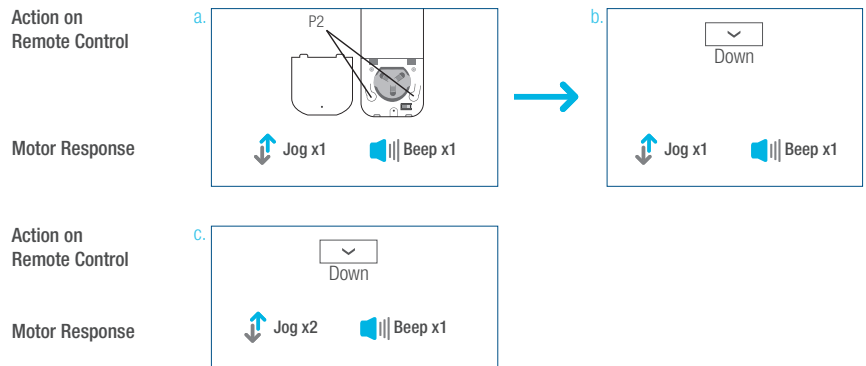

Roller or Sheer Mode

1. Roller Shade Mode - continue movement after a short press - Default Mode

a. Press and hold (about 5 sec) “Up” and “Down” buttons simultaneously until motor jog x1.

b. Press and hold (about 2 sec) “Stop” button until motor jog x2 and beep x3.

Action on Remote Control

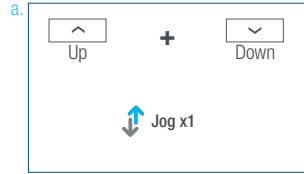

Motor Response

Action on Remote Control

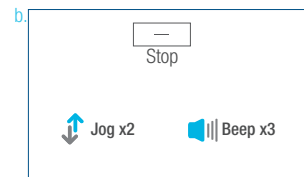

Motor Response

2. Sheer Shade Mode - jog movement after a short press (continue movement after a long press)

a. Press and hold (about 5 sec) “Up” and “Down” buttons simultaneously until motor jog x1.

b. Press and hold (about 2 sec) “Stop” button until motor jog x1 and beep x1.

Action on Remote Control

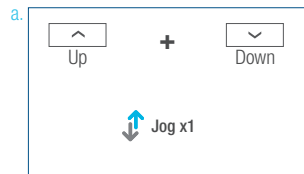

Motor Response

Action on Remote Control



Motor Response

Quick Index

Settings	Steps
1 Pairing	P1 (hold down for 2s) > Stop (hold down for 2s)
2 Switch Rotating Direction	Up + Down (hold down for 2s)
3 Setting Upper & Lower Limits	Upper Limit: Up (hold down for 2s) > Up + Stop (hold down for 2s) Lower Limit: Down (hold down for 2s) > Down + Stop (hold down for 2s)
4 Add / Remove Favorite Position	P2 > Stop > Stop
5 Roller Mode & Sheer Mode Switch	Up + Down (hold down for 5s) > Stop
6 Adjust Limits	Upper Limit: Up + Stop (hold down for 5s) > Up or Down > Up + Stop (hold down for 2s) Lower Limit: Down + Stop (hold down for 5s) > Up or Down > Down + Stop (hold down for 2s)
7 Pair / Unpair Additional Emitter	P2 (existing) > P2 (existing) > P2 (new)
8 Speed Regulation	Acceleration: P2 > Up > Up Deceleration: P2 > Down > Down

Troubleshooting

Issues	Possible Causes	Solution
The motor has no response	Battery in motor is depleted	Recharge with compatible AC adaptor and check connection and positioning of solar PV panel
	Insufficient charging from Solar PV Panel	Check connection and orientation of solar PV panel
	Remote control battery is discharged	Replace battery
	Battery is inserted incorrectly into remote control	Check battery polarity
	Radio interference / shielding	Ensure remote control and the antenna on the motor are positioned away from metal objects
	Receiver distance is too far from Remote Control	Move remote control to a closer position
	Power failure	Check power supply to motor is connected and active
	Incorrect wiring	Check that wiring is connected correctly (refer to motor installation instructions)
Motor beeps 10 times when in use	Battery voltage is low / PV (solar panel issue)	Recharge with AC adapter or check connection and positioning of solar PV panel
Cannot program a single motor (multiple motors respond)	Multiple motors are paired to the same channel.	Always reserve an individual channel for programming functions
		SYSTEM BEST PRACTICE - Provide an extra 15 channel remote in your multi-motor projects that provides individual control for each motor for programming purposes
		Place all other motors into sleep mode (ref to P1 button instructions)

Important: Before starting the programming, install the shade following the installation instructions provided.

For Honeycomb Shades, connect the battery cable into the slot located in the endcap, inside the headrail, **before** hanging the shades on the brackets.

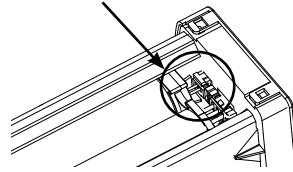

1a. Attach the Wand

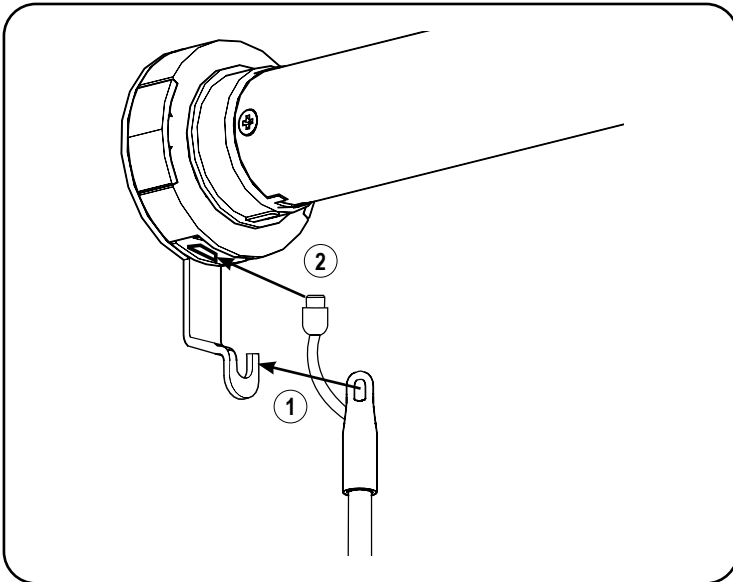

On Dual Shades, Roller Shades and Window Shadings, with the wand control buttons facing you, attached the top of the wand on the metal hook support (1) on the motor control side, then connect the cable into the motor head (2).

1b. Attach the Wand — Honeycomb Shades

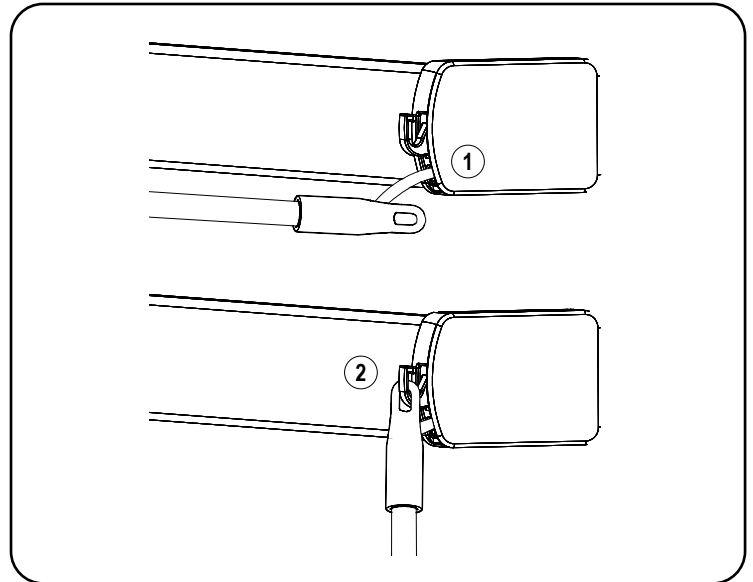

On Honeycomb shades, the wand will be already connected to the shade (1). With the wand control buttons facing you, attached the top of the wand into the plastic hook support on the motor control side (2).

2. Operate the Wand

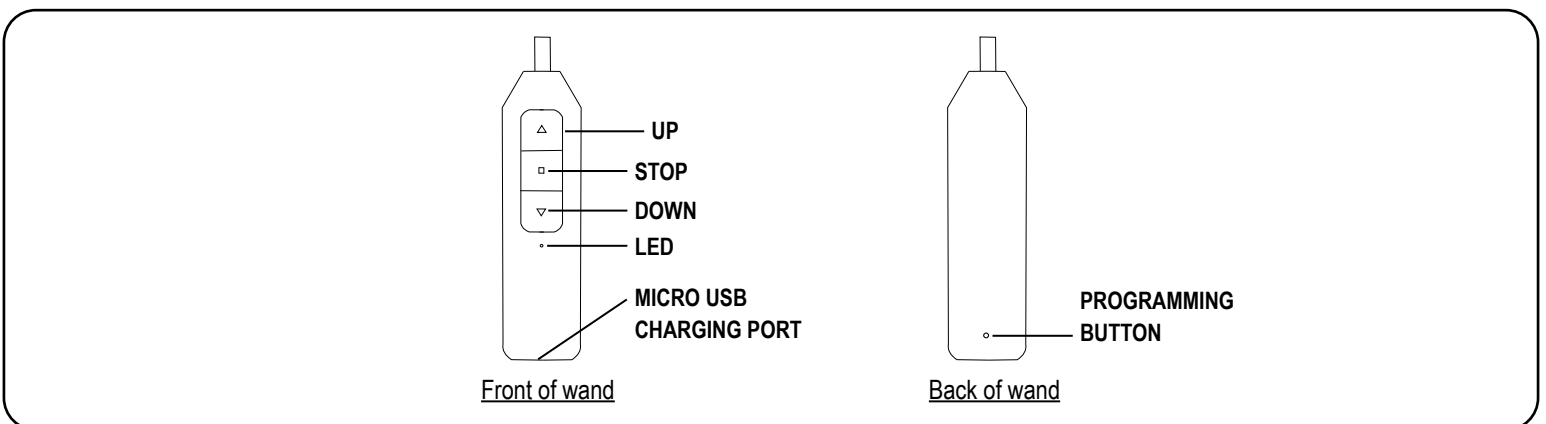

Roller and Honeycomb Mode:

- Press the **DOWN** or **UP** button to lower or raise the shade. Press the **STOP** to stop the shade at the desired position.

Window Shadings and Dual Shades Mode:

- Tapping the **UP** or **DOWN** button for less than 2 seconds will move the shade in short steps.
- Holding the **UP** or **DOWN** button down for more than 2 seconds before releasing will operate the shade at the standard speed.
- Press the **STOP** button to stop the shade at the desired position.

3. Set a Favorite Position

1 Move the shade to the desired position

2 Press and Release the PROG button

3 Jog x1

4 Press and Release the PROG button

5 Jog x1

IMPORTANT: Once the favorite position is set, the shade will always stop at the designed favorite position when passing by it.

4. Remove a Favorite Position

1 Move the shade to the favorite position

2 Press and Hold the PROG button for 7 seconds

3 Jog x2

5. Advanced Programming

IMPORTANT: Damage to shade may occur when operating the motor prior to setting limits. Attention should be given.

Switch between Roller and Window Shadings Mode

1 Press and Hold the STOP button for 5 seconds

2 Jog x1

3 Press and Release the STOP button

4 Jog x1

Adjust the Top and/or Bottom Limit

1 Move the shade to the limit that should be adjusted

2 Press and Release the PROG button

3 Jog x1

4 Adjust the shade to the desired limit position

5 Press and Release the PROG button

6 Jog x1

Factory Motor Reset

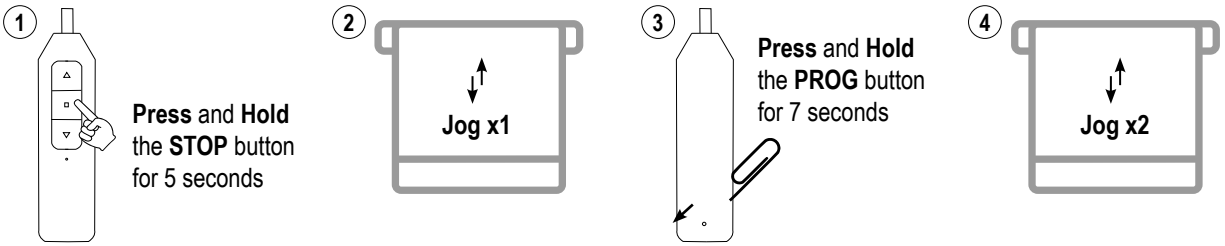

IMPORTANT: All limits will be erased. The motor direction will return to default and may need to be adjusted.

Reverse UP and DOWN Commands (Only if necessary)

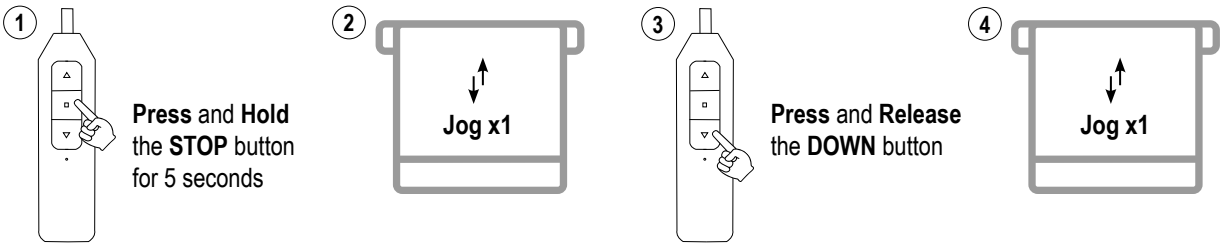

Set Upper and Lower Limits (Only after Factory Motor Reset)

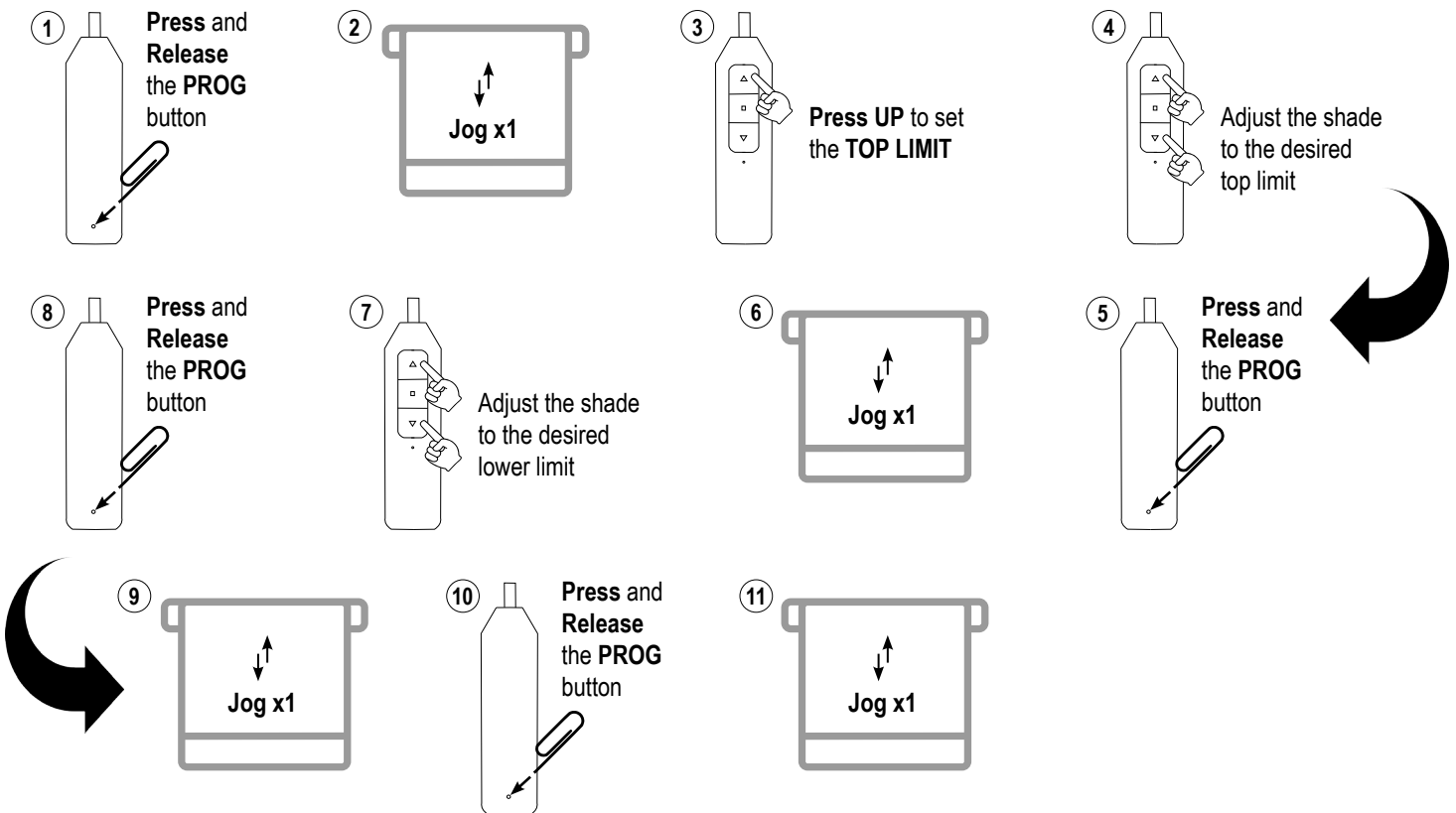

6. Charge the Battery

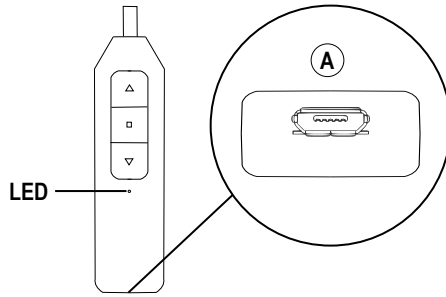

When the shade begins to operate slower than normal or only beeps when you attempt to operate, it is time to charge the battery. To Charge, connect a standard micro USB cable into the bottom of the wand (A) and into USB 5V/2A (max) power supply. A red LED on the wand indicates that the battery is charging. To fully charge the batteries, allow the batteries to charge for at least 1 hour after the LED on the wand turns green.

Note: A typical charge cycle can take between 4-6 hours.

Troubleshooting

Issues	Possible Causes	Solution
The shade is not responding	Built in battery is depleted	Recharge with compatible USB 5V/2A (max) adapter and a micro USB cable. Details under “6. Charge the Battery”
	Wand is not fully connected to the motor	Check the connection between the wand and the motor
The shade moves the opposite direction on the control buttons	The motor direction is reversed	See details under “Reverse Up and Down Commands”
The shade stops by itself before it reaches the top or bottom limit	A favorite position was set	See details under “4. Remove a Favorite Position”
The shade only moves in small steps after pressing the button	The shade is operating on Window Shadings/ Dual Shades mode	Switch to Roller/Honeycomb mode by following the steps under “Switch between Roller and Window Shadings Mode”
	The shade has no limit set	See details under “Set Upper and Lower Limits”

Child Safety

WARNING STRANGULATION HAZARD – Young children can be strangled by cords. Immediately remove this product if a cord longer than 22 cm or a loop exceeding 44 cm around becomes accessible. Rev 7/21 Print 7/21

MISE EN GARDE RISQUE D'ÉTRANGLEMENT – Les enfants en bas âge peuvent s'étrangler avec des cordes. Enlevez immédiatement ce produit si une corde mesurant plus de 22 cm devient accessible ou si le contour d'une boucle de plus de 44 cm devient accessible.

NOTE: The No Tools Mounting System will come with the shade installation brackets already attached. No drilling is necessary to install this shade. A Flat head screwdriver is needed to remove the No Tools Mounting System.

1. Install the No Tools Mounting System

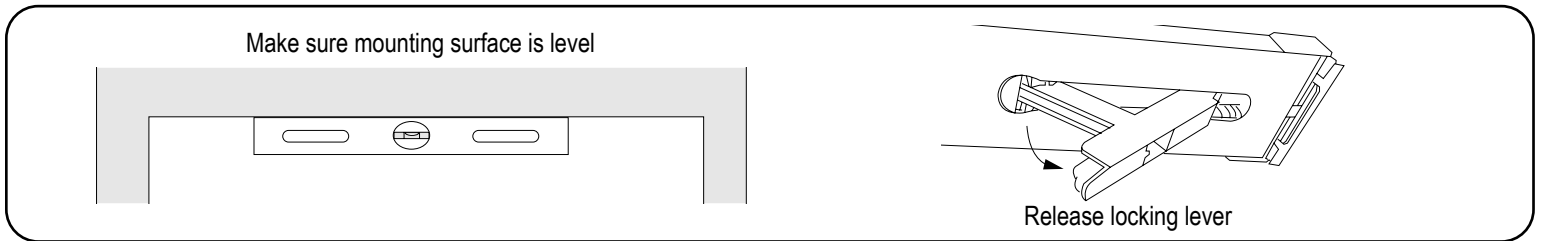

1a. Install the No Tools Mounting System - Placement and Width Adjustment

IMPORTANT: If mounting on a smooth surface such as painted aluminum or tile you must apply the double sided adhesive (included) to the end caps to keep the mounting system secure. Remove release liner from one side of the adhesive and apply to both end caps and press firmly to adhere.

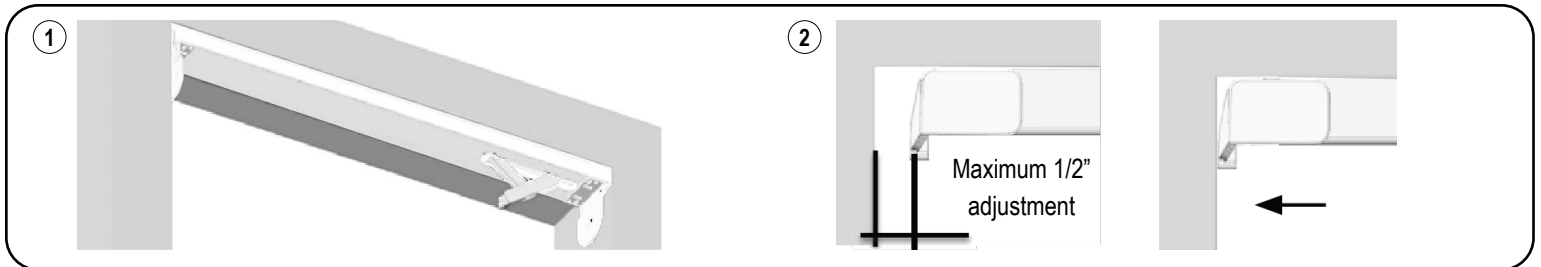

(1) Place the No Tools Mounting System in the window opening so that the end with the lever is up tight against the window casing. (2) If there is a gap at the non-lever end of the rail, simply slide the end cap until it touches the window casing. See END CAP ADJUSTMENT on page 2 if you accidentally pull the end cap out too far. If mounting on a smooth surface, remove the release liners from the double sided adhesive on the endcaps. Replace mounting system.

1b. Install the No Tools Mounting System - Lock in Place

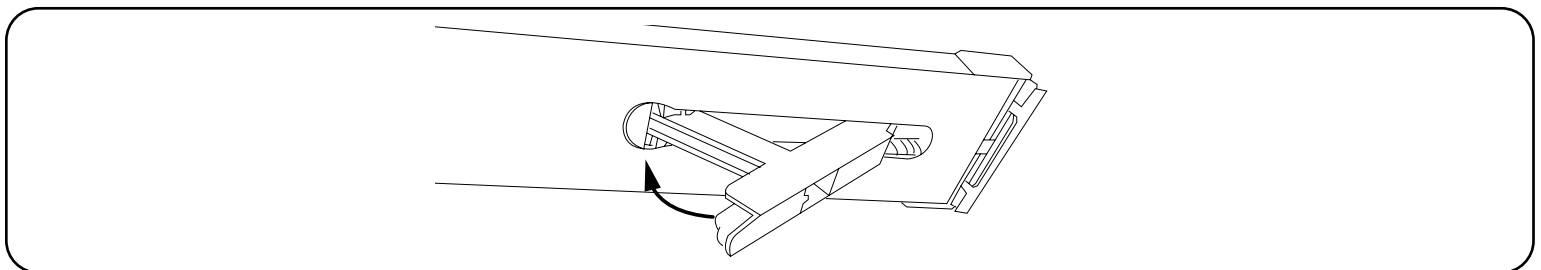

Make sure that the mounting system is level. Press up on the lever to lock the mounting system in place.

2. Install the Shade

Follow the instruction in the installation booklet that came with your shade to install the shade into the mounting brackets on the No Tools Mounting System.

3. Remove the No Tools Mounting System

IMPORTANT: First, remove the shade from the No Tools mounting system following the instructions in the installation booklet that came with your shade. Hold the mounting system securely with one hand. Use a flat head screwdriver to pry open the locking lever.

CAUTION: Lever will release abruptly. Keep hand clear of lever.

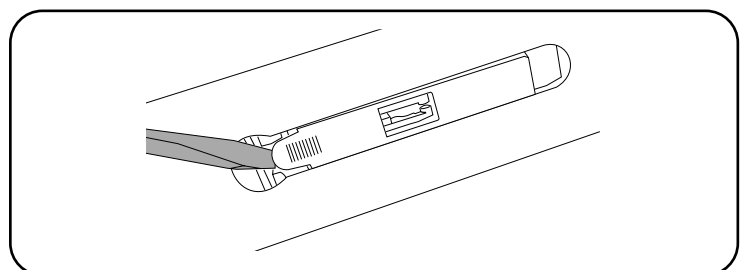

INSTALLATION INSTRUCTIONS

1. Adjusting Moveable End Cap

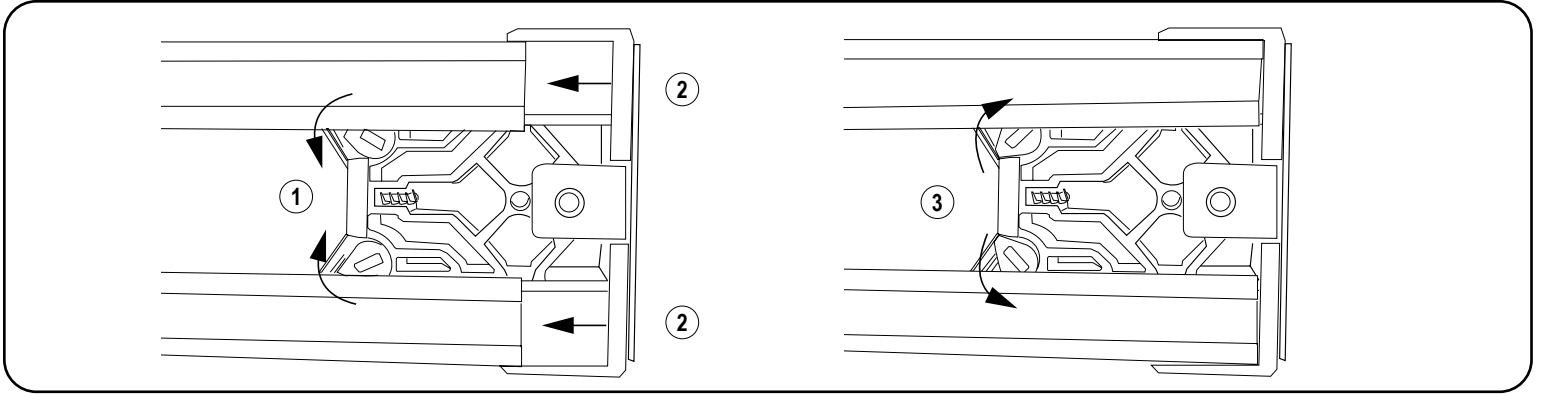

The moveable end cap is designed to only pull out with out tools. If for some reason the end cap needs to be compressed you will need a small flat head screw driver. (1) Use the screw driver to turn the locking tab release screws as shown. (2) Push the End Cap in. (3) Return the locking tabs to their original position.

Child Safety

⚠ WARNING/ADVERTENCIA	
5.1.3	Rev. 5/18 Print 5/18
	<p>Window Blind Cord Can STRANGLE Your Child. To prevent strangulation, purchase cordless products or products with inaccessible cords.</p> <p>La cuerda de la persiana puede ESTRANGULAR a su niño. Para evitar el estrangulamiento, compre alternativas cuerda o productos con cuerdas inaccesibles.</p>

SETUP CODE CODE DE CONFIGURATION

SBCAN

Getting to know your Smart Controller

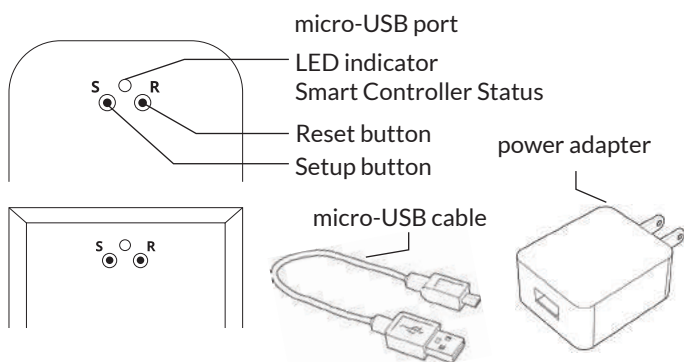

Smart Controller Status:
Flashing blue - Hotspot available
Flashing green - Connecting to the WiFi network
Pulsing cyan/blue-green - Connected to the Internet

Getting Started

- 1 Download the Neo Smart Blinds app**

Download the app to your phone or tablet by searching **Neo Smart Blinds** on Google Play or the App Store.
Note: Do not install Neo Smart Blinds Blue
- 2 Plug in your Smart Controller in reach of your home WiFi**

Choose a place not too far from your home router or a place you know has good WiFi signal strength. You will be able to change its location after, if necessary.
- 3 Create an account and choose the setup code written on the cover**

After opening the app, tap on Create one to create a new account. Enter a valid email address and choose a password, select the region time zone from the place where the Smart Controller will be located. Choose the setup code written in the cover and tap on Register.
- 4 Follow the app step by step to add the Smart Controller**

Have in hand the home WiFi password. It will be necessary to connect the Smart Controller to the Internet.
Note: Some Android users won't be connected quickly to the hotspot. If it is the case, please wait about 10 seconds before returning to the app. During this time, your device may notify you that the hotspot does not have Internet access, and will prompt you whether you want to remain connected. You need to select the option that will allow you to keep connected before returning to the app.

System requirements

- A strong WiFi signal (3 bars or more) in the location where you will setup your Smart Controller.
- The Smart Controller only supports 2.4GHz WiFi (IEEE 802.11b/g/n), not 5GHz. WiFi security needs to be set to WPA-PSK or WPA2-PSK.
- A smartphone or tablet running Android 5.0 (Lollipop) or higher, or iOS 8 or higher is needed.

Troubleshooting

The home WiFi doesn't appear in the step 4

Try rescanning, if the problem persists, you will need to reposition the Smart Controller to a place with stronger WiFi signal. In this case, exit the process (tap on the menu, then tap Your Rooms), replace the Smart Controller and start over.

The Smart Controller LED in the bottom is not blinking blue

The process fails in the last step

Press the S button for 10 seconds, then press the R button once and start over. Pay special attention when typing the WiFi password.

Need more help?

Visit neosmartblinds.com/smartcontroller for detailed instructions about how to use the app and troubleshooting.

Integrations

Smart home devices

Visit neosmartblinds.com/smartcontroller-integrations for detailed information about connecting to Amazon Alexa, Google Home and other systems.

Control4

Please send an email to tech@neosmartblinds.com with your name, your email and your company's name. This information is necessary to always send to you any further driver update.

Legal Information

FCC

This equipment has been tested and found to comply with the limits for a Class B digital device, pursuant to Part 15 of the FCC Rules. These limits are designed to provide reasonable protection against harmful interference in a residential installation. This equipment generates uses and can radiate radio frequency energy and, if not installed and used in accordance with the instructions, may cause harmful interference to radio communications. However, there is no guarantee that interference will not occur in a particular installation. If this equipment does cause harmful interference to radio or television reception, which can be determined by turning the equipment off and on, the user is encouraged to try to correct the interference by one of the following measures:

- Reorient or relocate the receiving antenna.
- Increase the separation between the equipment and receiver.
- Connect the equipment into an outlet on a circuit different from that to which the receiver is connected.
- Consult the dealer or an experienced radio/TV technician for help

Contains transmitter module FCC ID: COFWNMNB11

To comply with FCC/IC RF exposure limits for general population/uncontrolled exposure, the antenna(s) used for this transmitter must be installed to provide a separation distance of at least 20 cm from all persons and must not be co-located or operating in conjunction with any other antenna or transmitter.

IC

This device complies with Industry Canada's licence-exempt RSSs. Operation is subject to the following two conditions:

- This device may not cause interference; and
- This device must accept any interference, including interference that may cause undesired operation of the device.

This device meets the exemption from the routine evaluation limits in section 2.5 of RSS102 and users can obtain Canadian information on RF exposure and compliance.

Contains transmitter module IC: 10293A-WMNB11

This End equipment should be installed and operated with a minimum distance of 20 centimeters between the radiator and your body.

